



Lighting System Interconnection Levels

Prepared By:

Ronald M. Weber

Tyco Electronics Corporation

3101 Fulling Mill Road

Middletown, PA 17057

Disclaimer: All information, including illustrations, is believed to be reliable. Users, however, should independently evaluate the suitability of each product for their application. Tyco Electronics makes no warranties as to the accuracy or completeness of the information, and disclaims any liability regarding its use.

TABLE OF CONTENTS

I.	Scope	1
II.	Introduction	1
III.	Background	4
IV.	The Eight Levels of Application for Electronic Products	7
V.	The Eight Levels of Lighting Interconnects	10
VI.	Conclusion	17
VII.	References	18

I. SCOPE:

The lighting industry is now engaged in a metamorphosis similar to that experienced by the electronics industry in the 70s and 80s. At that time, to address this emerging market, AMP Incorporated developed the six Electronic Packaging Levels. These are now well grounded and used throughout Tyco Electronics to categorize interconnects. In this paper, the author establishes a similar hierarchy directly applicable to current and future lighting systems

II. INTRODUCTION

Since mankind first populated Earth, light was generated by burning a substance, typically wood, that coincidentally also created heat for warmth and cooking. Because it was readily available, plentiful and easily ignited, wood served this purpose for most of those years. Even today, wood continues to be the primary source of light and heat in a number of developing countries.



Fig.1 Fire: the most basic source of light

Eventually, other carbon-based burnable fuels were discovered that provided light when burned. Refined animal and vegetable oils, waxes and eventually gases provided much more uniform and brighter sources of light. As time progressed, the quality of light was ever so slightly improved as impurities were removed from the substance being burned. Nonetheless, there was still a finite amount of light that could be generated by burning.

A. *THE BURNING YEARS*

In the early 1800s, electricity was still being understood, however, early experimentation with electrified carbon filaments showed promise as a potential non-extinguishable source of light. The problem was a very short, finite life as the filament oxidized while being electrically heated. Just before the turn of the last century, Thomas Edison discovered that by placing the filament in an inert gas, the life of the filament is dramatically increased to the point of being a

practical light source. This revelation set off the next 100 years of lighting development centered on electrically heating a filament or gas to create light.

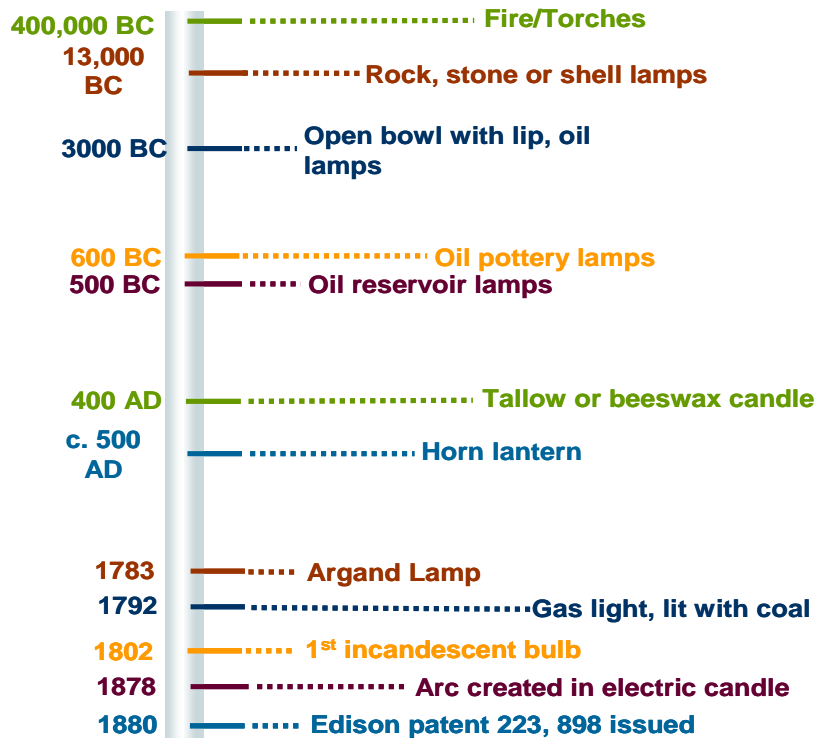

Fig. 2 Pre-electric timeline

B. THE ERA OF ELECTRICITY

For the bulk of the past 125 years Edison’s incandescent bulb reigned supreme as it brought a new, compact and intense light to those previously only familiar with oil or gas lamps. When Edison’s first light bulb was installed in a building, a pair of wires provided the AC or DC power to the bulb. No other options existed and minimal interconnect technology was involved other than the venerable “Edison Base” screw-in light socket. This changed as newer light sources were developed. These new light sources required the creation of specialized sockets uniquely suited to take full advantage of the capabilities of these new light sources.

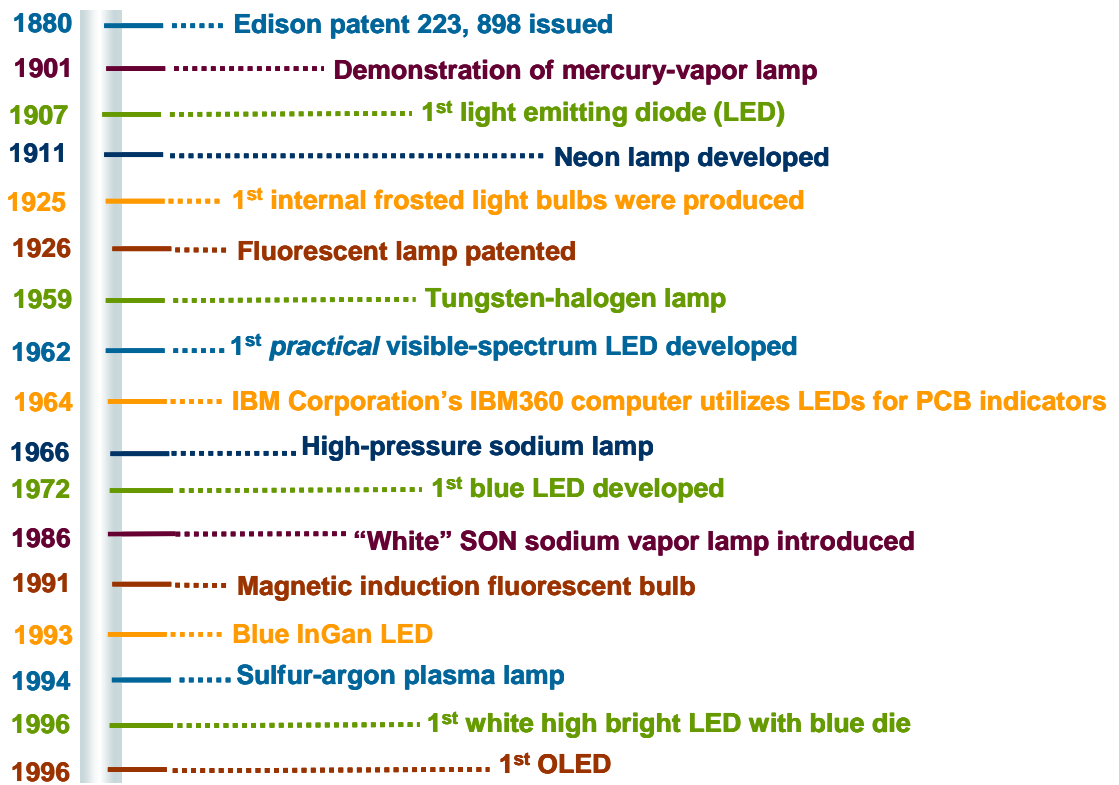

Fig. 3 Post-electric timeline

Fast forward almost 100 years from the invention of the Edison bulb to the advent of solid state lighting (SSL). We are now at the early stages of a similar epoch that will be just as disruptive to the lighting industry as Edison's light bulb. As a new industry develops around this novel light source, a myriad of interconnect options exist that now pose a dilemma to all those involved in lighting design and integration. It affects everyone from the light source supplier to the final lighting contractor responsible for installation. Simply put and broadly stated – the dilemma is: What are my interconnect options? The answer to this is a rather ambiguous, "it depends". There currently is no clear answer to this since many options exist; it all depends where the interconnect lies within the overall system.

The solution is a method that better defines each level of interconnects thereby isolating the specific connector application as well as the products and options available. This paper proposes a classification system that clearly defines natural demarcations that are inherent in all lighting systems.

III. BACKGROUND

As mentioned in the introduction, a broad range of light sources and related sockets were developed in earlier years as new light sources were created. The earliest light source—the incandescent bulb—was developed around 1802 and refined by Thomas Edison in 1879 to become a reliable, mass-marketable product. At that time, Edison acknowledged the finite life of his light source and the necessity for replacement. To facilitate ease of replacement, Edison took his inspiration from the screw top of a kerosene can and, in 1881, developed the screw-in lamp base with a central, glass-insulated contact with which we are all familiar [1]. As a result, the development of this connector system for the new incandescent bulb dramatically accelerated adoption of this new light source, since it could readily be retrofit into familiar light fixtures of the time (e.g., gas, oil and candle lamps).

By placing the new light source into fixtures familiar to the consumer, they were more readily accepted. Even today, electric light fixtures continue to resemble these of years past as seen in the multitude of “candelabra” style light fixtures and the table lamps that mirror oil lamps of old. As the electrification of the world progressed, so did the integration of sockets into fixtures.

Of course, this transition required consumer education. As the popularity and adoption of these new light sources spread, user instructions were posted next to wall switches to familiarize people with their use. The label shown in Fig. 5, while humorous today, was a necessity at the turn of the last century since, as today with compact fluorescent lamps (CFL) and light emitting diode (LED) illumination, consumers needed to be educated on the use of the new light source.



Fig. 4 Electric light instructional label/plaque

It was only after widespread acceptance that the light bulb started making its way into new, novel, and decorative light fixtures. An entirely new segment of the lighting market, one that is purely decorative, began to develop and gain market acceptance. Lighting for purely decorative purposes continues today and has even developed into a lighted advertisement subset (e.g., beer and product promotion signs, neon signs) that are still decorative in nature.

A number of years passed in which the incandescent bulb was the only electric light source commercially available for general illumination. Shortly before World War II, the fluorescent bulb was released, offering the world a uniform, linear light source suitable for illuminating large spaces. As with the incandescent bulb, the characteristics of this light source required a new socket to allow easy replacement of the fluorescent bulb.

The now familiar “tombstone” socket shown was developed specifically for these linear light sources. Unlike the incandescent bulb, the fluorescent bulb could not be readily retrofit into existing light fixture designs so a new fixture design was required. The new fixture design, coupled with the harsh, blue-white light emitted by the early bulbs meant this new light source would find few residential applications since consumers wanted the warm glow of an incandescent bulb. As a result, the fixture design that developed was geared toward commercial applications with a focus on utility rather than aesthetics. Typically rectangular or square in shape, these fixtures are used with one or more fluorescent bulbs and are now ubiquitous in industrial and commercial applications.

Driven by the growing requirements of energy conservation, it was not until the 1990s when the efficient fluorescent bulb morphed into the now familiar compact fluorescent lamp (CFL) targeting residential/consumer use. Given the huge installed base of Edison sockets around the world, it was natural that the CFL was offered with an Edison base for easy, energy efficient, retrofit replacement. Even with the Edison base, the initial blue-white CFLs found poor consumer acceptance due to the harsh light and poor color rendition. Newer, higher quality warm-white products now on the market are finally gaining consumer recognition and are making their way into homes. It should be noted that as CFLs gain acceptance, certain states (California) now mandate that all energy efficient bulbs incorporate a new GU-24 bulb base rather than the Edison base thereby precluding installation into legacy fixtures. How this will develop and spread to other areas is being closely monitored. With that said, advocates of SSL readily point out the initial market failures of CFL and the need to provide a consumer-friendly lighting solution to prevent a similar initial market failure [2].

We now find ourselves with a new solid state light source: the light emitting diode (LED). Although this phenomenon was first observed in the early 1900s, it was not until the turn of the

current century that brought the development of InGaN and AlGaNP technology. This technology, along with advanced phosphor development, moved LEDs out of the realm of indicator lights and onto a growth path that offered the possibility of true “lighting class” LEDs. With the development and growth of LED technology, we see many similarities to the market path taken by earlier lighting technologies. The initial migration into retrofit applications and eventual transition into entirely new lighting designs is the most obvious similarity that comes to mind although more subtle technological similarities can be identified and will be shown later in this paper.

The last background comment that needs to be presented is the remarkable similarity between SSL and the evolution of the personal computer. Those old enough to remember the rise of the personal computer (PC) in the early 1980s can remember the lack of structure and standards among the start-ups. At their start, PCs were typically soldered conglomerates of parts and devices with little commonality between manufacturers. Eventually, the PCs began to be segmented into subcomponents. The socketing of microprocessors and memory as well as the pluggability of disk drives and peripherals all were the end result of this segmentation. Driven by the push for manufacturing efficiencies as well as developing industry standards, this segmentation allowed for the out-sourcing of assemblies, lowered costs, eased final assembly, and allowed for interchangeability between component manufacturers. There are a number of similarities developing with SSL that will be explored later in this paper.

As these common segments began to solidify across the industry during the 1980s, AMP Incorporated naturally began to try to create order out of these segments so connector selection and identification was easier for our employees and customers. In his 1992 paper, Richard Granitz first outlined the original Six Levels of Electronics Packaging [3]. Out of this effort rose the Eight Levels of Electronic Packaging that Tyco Electronics personnel are now intimately familiar with and that is likewise commonly acknowledged in the electronic packaging world.

IV. THE EIGHT LEVELS OF APPLICATION FOR ELECTRONIC PRODUCTS

Before delving any further, a review of the existing Eight Levels of Application for electronic products is in order to level-set the reader and brush-up on the hierarchical nature of the levels. Those readers well familiarized with these levels can continue to the next section or read on as a refresher.

As seen below in Fig. 8 that shows an image of a generic electronic chassis, the existing system is clearly based on common electronic assemblies. The microprocessor sockets, mother-daughter board arrangements as well as the enclosure I/O are all visible and readily identified.

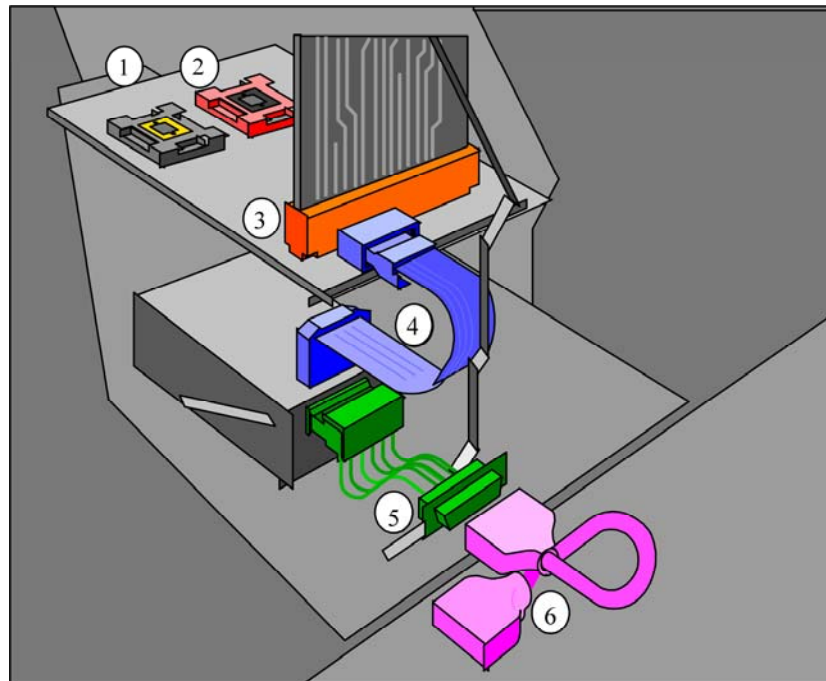

Fig. 5 Original six levels of electronic packaging

Exploring each level a little closer, let's look at the differentiators of each level.

Level 1: Primary Element Connection Level—Basic connection to the primary electronic element. In the microprocessor area, this is typically a wire bond to the electronic die.

Level 2: Component to Circuitry—Component lead to PCB trace. This is almost always a soldered joint used to connect an electronic device to a PCB.

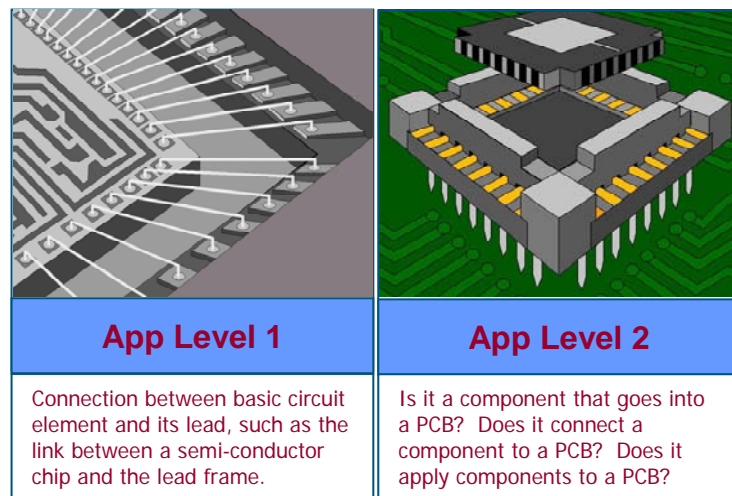

Fig. 6 – Level 1 and 2 Connections

Level 3: Circuit to Circuit—Usually connects PCBs within an assembly. The most common implementation is the connection between a motherboard and a perpendicular or parallel daughter board.

Level 4: Subassembly to Subassembly—Connections between two subassemblies within a chassis. In this case, it is the first level where cabled connection is found and is typified by the connection between an internal power supply and a circuit board in a chassis.

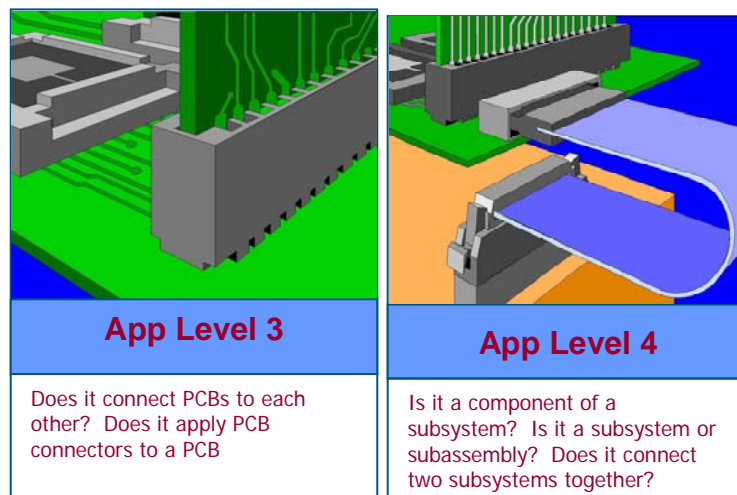

Fig. 7 – Level 3 and 4 Connection

Level 5: Subassembly I/O—Connections between a subassembly(ies) and chassis I/O. This particular level almost always terminates in a bulkhead-mounted connection. It serves as the I/O to a chassis and can be either power or data.

Level 6: System to System—Connections from one system to another system. An excellent example of this level would be the connection between a PC and a printer.

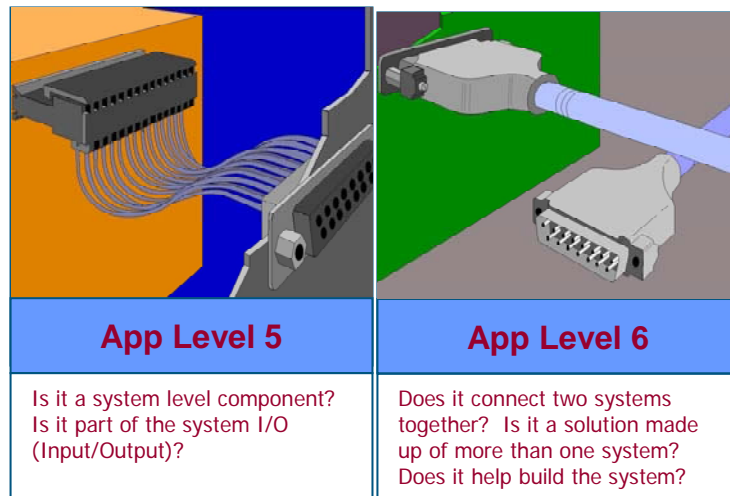

Fig.8 – Level 5 and 6 Connections

Level 7: Building Infrastructure—Typically part of a building’s permanent electrical system. This generically can be thought of as the permanent power or data system within a building.

Level 8: Outside Plant—Encompasses all interconnect systems outside the building. This final level covers a very broad range of systems outside of the building that cover power, data and telecom. In the telecom world, this is often referred to as the “outside plant” with the network interface device (NID) acting as the demarcation point to the Level 7 building systems. Given the complexity of the multitude of devices that can exist in Level 8, it is conceivable that this level could be further segregated into additional levels, but this is beyond the scope of this document.

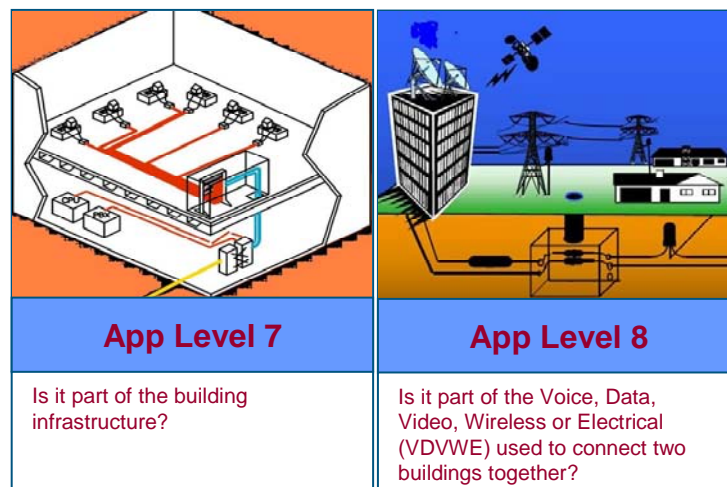

Fig. 9 – Level 7 and 8 Connections

V. THE EIGHT LEVELS OF LIGHTING INTERCONNECTS

At this point, we've reviewed lighting technology as well as the Eight Levels of Application. The remainder of this paper combines the two to develop a logical system that is directly applicable to lighting systems.

Lighting is no longer being thought of as an "electrical" product. The new technologies being rolled out and developed are resulting in the "electronification" of lighting. This lighting "electronification" offers a number of system parallels to the familiar electronic packaging seen in products ranging from cell phones to personal computers, albeit at a larger scale. Similarly, lighting designers are struggling with these new technologies and how to integrate them into new fixtures. Questions on which interconnect to use often confound the designer and are typically left until the last design step when a distributor catalog is picked up and something that "looks" like it will work is selected. Will the selected connector work? Perhaps, yes. Is it the optimum selection for the application? Probably not.

What a designer needs is a method that defines each level of lighting interconnects in a manner similar to what is done with electronic systems. When doing this, we can better isolate the specific connector applications and define the products and options available to the lighting designer. From an industry-wide standpoint, this will bring order to the design process and introduce connector consideration earlier in the design process where proper consideration and selection of the connector is best situated.

Proposed is a classification system that clearly defines natural demarcations inherent in *all* lighting systems regardless of the light source. While exceptions exist, eight levels of interconnects are easily identified in lighting systems and can be readily defined. What follows is a description and explanation of these levels. Identification of these levels thereby forms the basis for better identifying and communicating interconnect options available to all involved in lighting design and integration. As an added benefit, it provides a vehicle to identify product needs and gaps at each level that those in the connector industry are well posed to fill.

The proposed Eight Lighting Interconnect Levels are:

- L1. Light Element Connection
- L2. Light Source Device Connection
- L3. Light Source Assembly Connection
- L4. Internal Power Supply to Light Source Assembly or Light Source Device
- L5. Primary Fixture Power

- L6. Installation Power Distribution
- L7. Building Infrastructure-Line Power to Site Installation Power
- L8. Outside Plant Power Distribution System

To further clarify these levels, a rough schematic representation is shown below in Fig. 17 that highlights each of the segments. It should be noted that while Levels 5–8 are typically common regardless of the light source, Levels 1–4 often differ markedly due to the designs of the light source.

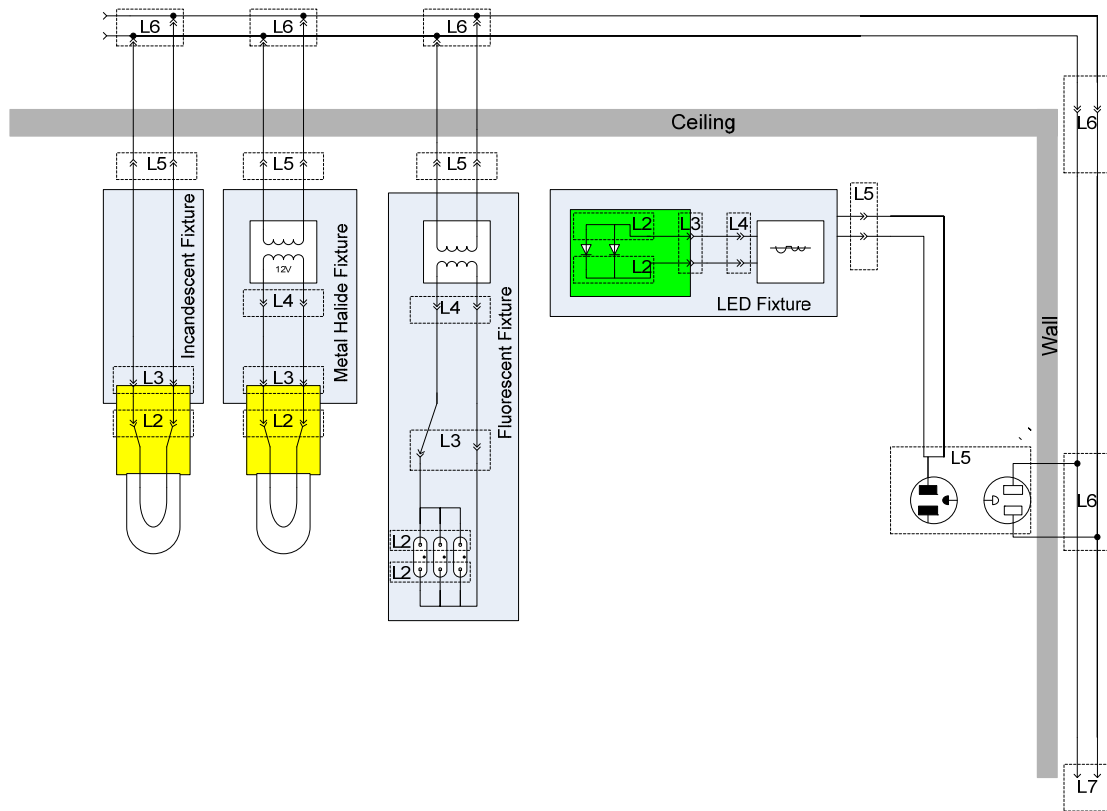

Fig. 10 Lighting level schematic

The intent of these levels is to provide differentiation between the different interconnect needs typically found in lighting applications. Detailed definitions of each of the proposed eight levels with lighting examples follow.

Level L1—Basic connection to the light emitting element. For an LED, this would be the wire bond to the die. For an incandescent bulb, it would be the weld to the tungsten filament.

Level L2 — Interconnection to the light source. In the case of an incandescent bulb, this would be an Edison base. For T5/8/12 fluorescents, it is the “tombstone”. For LEDs, this is typically a solder joint.

Level L3—Interconnection to the light source assembly. For an Edison base, this could be a crimp contact. For a fluorescent tombstone, this is typically either a poke-in or crimp termination. For LED assemblies on a printed circuit board (PCB), this could be a wire solder joint or a separable connection providing power into the assembly or to another assembly.

Level L4—Connection from an internal power supply to the light source assembly or device. For LEDs, fluorescent and metal halide systems, it is the power supply/driver/ballast output connection. This level is not required for primary direct-wired fixtures.

Level L5—Primary power interconnect from the primary installation wiring to the fixture.

Level L6—Fixture/installation primary power distribution. The installation is defined as the area where the light source(s) is(are) installed for use. This could be an automobile, building, office cubicle, room, or other similar area. An example of this would be a manufactured wiring power system used in an office environment to distribute primary power in an office cubicle. Another example is a manufactured wiring system used to connect and distribute power to lighting fixtures in a suspended ceiling.

Level L7—Premises line power feed to the installation power distribution (L6) or power source (L5). This is typically line voltage of 120VAC, 220VAC or, in some lighting applications, as high as 347VAC.

Level L8—Outside plant electrical power distribution system. It is similarly made of a number of systems with natural demarcations that could serve as the basis for a future paper on outside plant electrical levels but for the purposes at hand, we will refer to all outside plant levels as a single level L8.

At this point, it should be evident that there are marked similarities between the above lighting levels and the original Eight Levels of Electronic Packaging, to the point that Levels 7 and 8 are identical. The similarity is further illustrated in Table 1 below:

	ELECTRONIC	LIGHTING
	Primary Element Connection	Light Element Connection
	Component to Circuitry	Light Source Device Connection
	Circuit to Circuit	Light Source Assembly Connection
	Subassembly to Subassembly	Internal Power Supply to Light Source Assembly or Light Source Device
	Subassembly I/O	Primary Fixture Power Input
	System to System	Installation Power Distribution
	Building Infrastructure	Building Infrastructure Power to Building Power
	Outside Plant Power Distribution	Outside Plant Power Distribution

Table 1. Comparison between lighting and electronic levels

From an interconnect standpoint, each level may have unique interconnect needs or, it may have a common need when compared to other adjacent levels. Certainly, if a common interconnect can be used in multiple levels, there are certain manufacturing and procurement benefits that can be realized, but this must always be balanced against technical and practical requirements for each level. There are, however, some generalities that can be drawn for connector types used at each level. Below we will investigate Levels L1–L6 since these are levels most closely related to lighting systems we’re commonly familiar with. Levels L7 and L8 will therefore be ignored for the most part. At the most basic level, a Level L1 connection is the first connection that is made to a lighting element. As shown in a standard incandescent light bulb, this is a wire weld where the tungsten filament connects to support wires. In a fluorescent fixture, it is similarly a welded connection between the element and the electrode. Finally, in an LED, it is the wire bond between the die and a lead-frame.

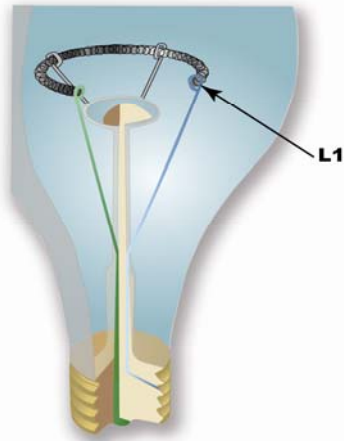

Fig. 11 Incandescent

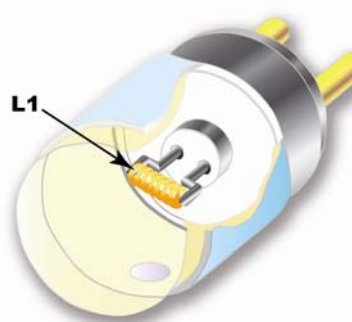

Fig. 12 Fluorescent

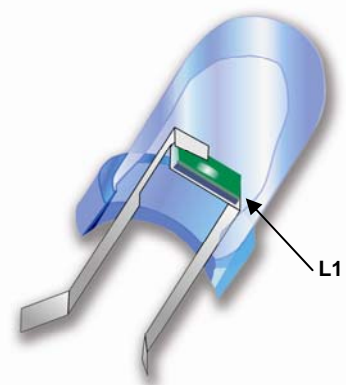

Fig. 13 LED

Moving up a level to Level L2, this level is the first where a separable connector might be first implemented. The most common, recognizable termination at this level is the ubiquitous solder joint. As one might expect, the soldered LED termination to a PCB is a very common example found in SSL implementations. In traditional lighting, the socket used to connect to a lamp is an ideal example of an L2 termination. In incandescent implementations, the Edison-base screw base is the most recognizable. In fluorescent fixtures, the bi-pin “tombstone” connector readily identified in fluorescent fixtures is yet another example of an L2 termination. Of course, given the wide range of lamp styles available, there are an equal number of sockets too numerous to list that can also be similarly classified as L2 terminations.

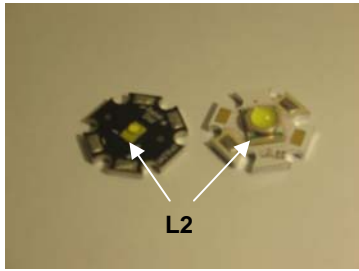

Fig. 14 LED star-board solder joints

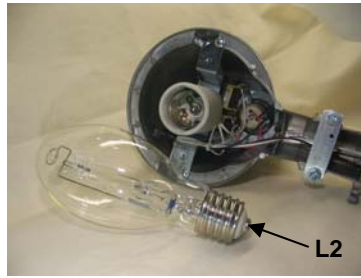

Fig. 15 Metal halide incandescent screw base

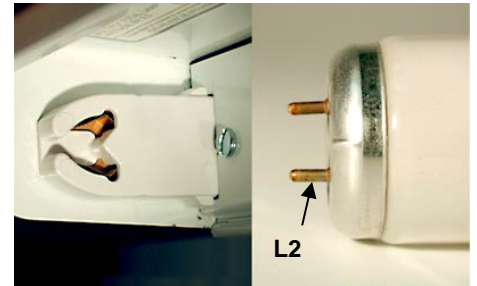

Fig. 16 Fluorescent bi-pin

At Level L3, wires are used that require some sort of connection method to provide power to an L2 socket or directly to the lighting device. In some instances, the wires can be soldered directly to the device and is indeed commonly done within the SSL assemblies. Tyco Electronics recently released the SMT Poke-In connector that provides a poke-in L3 termination to a printed circuit board thereby eliminating the need to solder the wire to the board. In other instances, it can also be the interconnection between circuit board assemblies as can be seen with the Hermaphroditic Board-to-Board connector used for SSL strip lighting. On the traditional lighting side, an L3 termination is typically just an FASTON, screw terminal, or poke-in terminal on the side or base of an Edison socket or fluorescent tombstone.

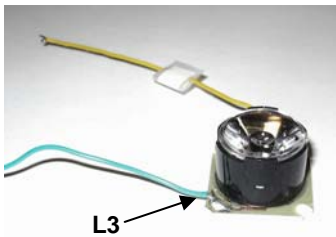

Fig.17 Soldered wire joint

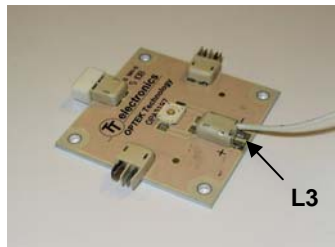

Fig.18 Tyco Electronics SMT Poke-In wire termination

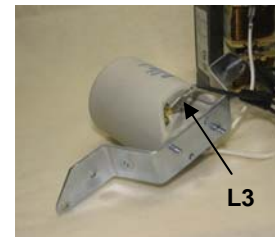

Fig. 19 FASTON quick-connect

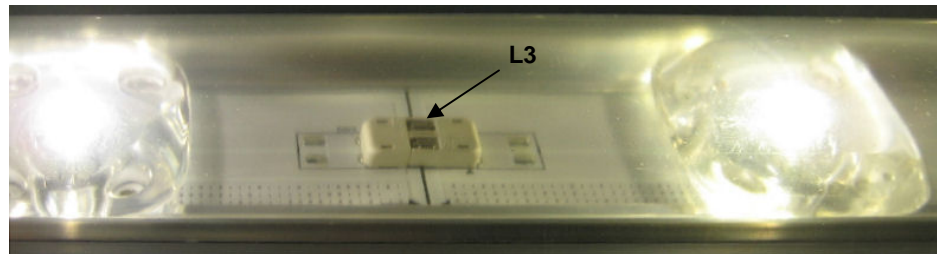

Fig. 20 Tyco Electronics Hermaphroditic Board-to-Board connector

Level L4 is the primary connection to an intermediate power source of the lamp. With an LED lamp, this would be the connection to the LED driver. For fluorescent lamps, this is the connection to the ballast. In both instances, this can be a separable plug and receptacle connector, a poke-in

connector on the driver board, or as simple as a wire nut connecting the wire from a lamp to a wire from the driver/ballast. Of course, since most incandescents do not require an intermediate power source, most incandescent lighting fixtures do not have a Level L4.

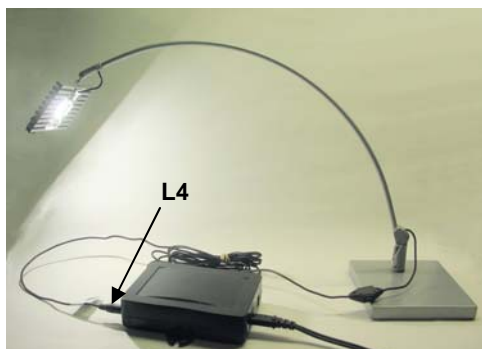

Fig.21 LED desk lamp

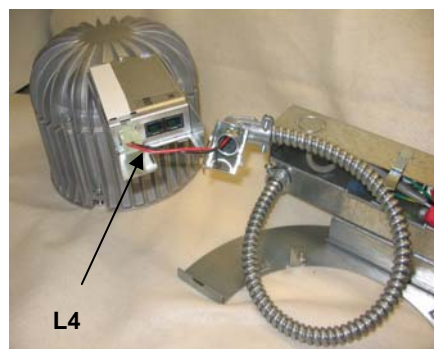

Fig. 22 LED recessed fixture

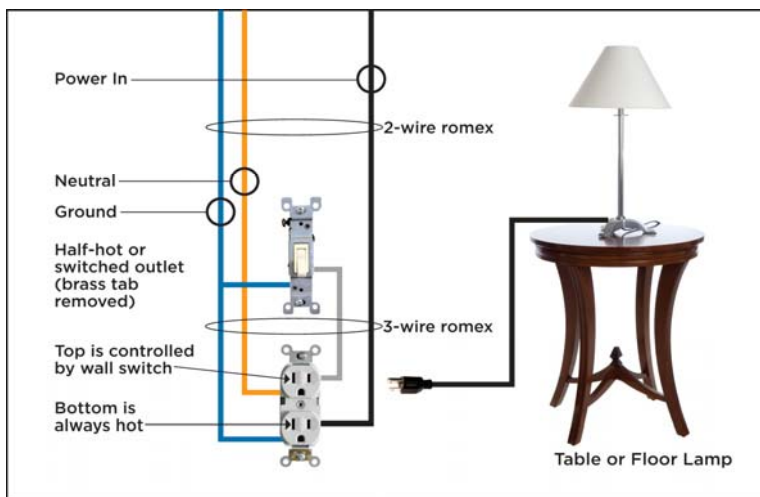

Fig. 23 AC power connection



Fig. 24 Fluorescent troffer connections

Continuing away from the lamp, we come to Level L5 which is the primary power connection to the fixture. This is a separable connector and is typified by a standard plug and receptacle configuration. In North America, this is the NEMA compliant two or three prong plug. In Europe and other locations, this is the DIN two pin plug. Since industry standard AC plugs are used, in most instances, this is a 120VAC/220VAC/277VAC/347VAC power source for most lighting applications. In some regions of the world, electrical codes allow recessed lighting fixtures to be pluggable using a Tyco Electronics NECTOR connector or equivalent as the primary power connection.

Also worth mentioning at this point is that there are a number of efforts taking place around the globe that promote low voltage DC as a primary power source for lighting. Immediately below is

one such system proposed by the EMerge Alliance. There is no doubt that similar DC primary power connection standards will develop for L5 and higher as these efforts mature.

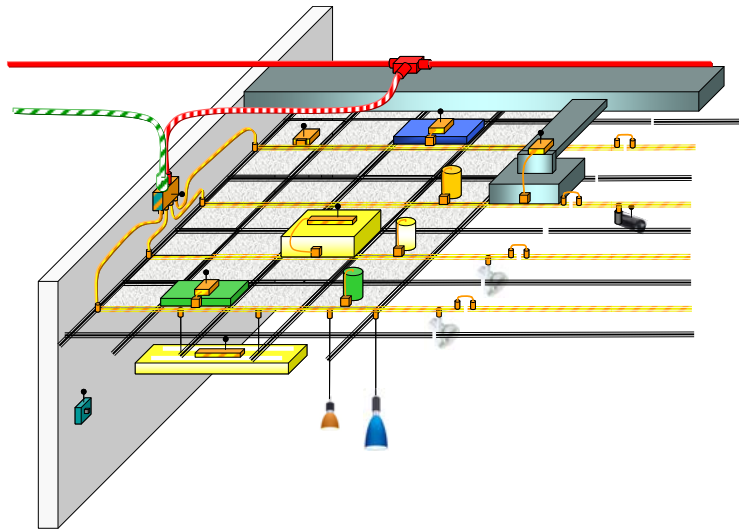

Fig.25 EMerge Alliance compliant DC power system

The last level to be discussed in this paper is Level L6. It is best characterized as the power distribution that takes place in the walls of a building. In almost all instances, this level is transparent to most end users but serves a vital role in distributing and providing power to the lighting fixtures. One such example of an L6 connection can be seen by simply removing the wall plate to an electrical outlet—the building wiring is either poked-in or screw terminated to the receptacle assembly. With ceiling or recessed lighting fixtures in North America, the L6 connection takes place in a junction box in the fixture. This box contains a screw terminal block or pigtailed wires from the fixture that are terminated to the building wiring with wire nuts or free-hanging poke-in terminations.

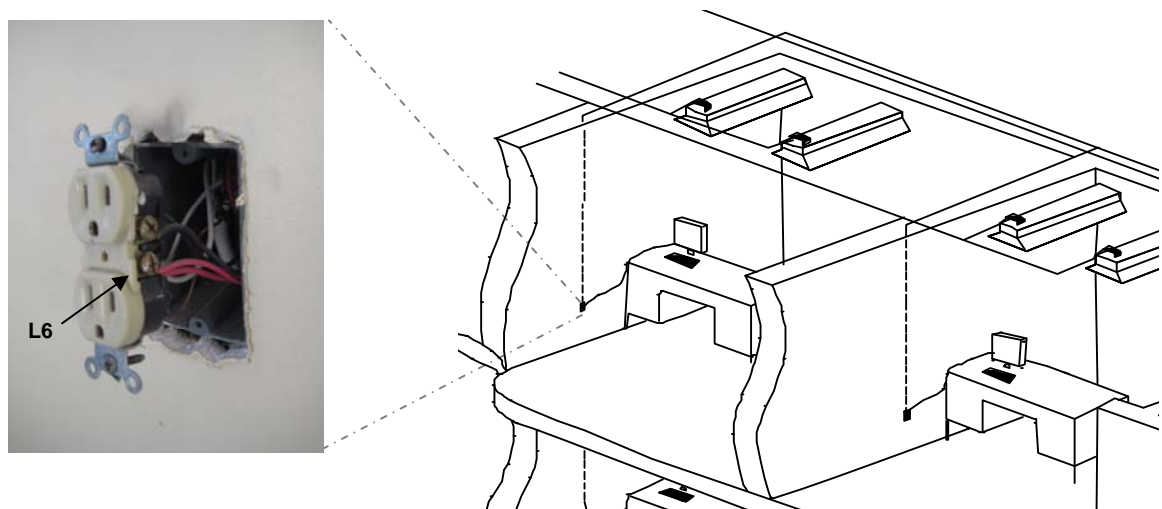

Fig. 26 AC receptacle screw wire termination

As mentioned earlier in this paper, Levels 7 and 8 will not be discussed since they are the same for both the lighting and electronic levels. They encompass many power distribution nuances beyond the lighting scope of this paper.

VI. CONCLUSION

At this point, the reader should be familiarized with the Eight Levels of Lighting Interconnects and their relevance to Tyco Electronics' efforts in the lighting industry. The proposed interconnect level classification system is intended to simplify discussions concerning connectors and create a common language for interconnects in the lighting industry. To validate the proposed approach, the writer recently observed a similar nomenclature in use in a recent paper presented at a conference by Philips Lighting, a division of Koninklijke Philips Electronics N.V., which classified components within their lighting products. By creating these levels and educating both ourselves and our customers, connectors can be further classified, promoted, and discussed as being appropriate for specific levels. Indeed, the emergence of SSL light sources and their dependence on thermal connectors may even prompt discussions on similar thermal connection levels (e.g., T1, T2, T3, etc.) to correspondingly provide structure to the thermal interfaces in an SSL system. One could even envision a discussion, for example, in which a customer inquires about our connector offerings for L2 terminations to which we respond with our portfolio of L2-suitable connectors.

This system offers room for growth and expansion as the electronification of the lighting industry continues and as new light sources such as organic light emitting diodes (OLEDs) are further developed. The PC-centric system upon which it is based remains in widespread use and the levels defined are now generally accepted in the industry. The writer's intent and hope is that the lighting levels proposed in this paper gain similar acceptance in the lighting industry.

VII. REFERENCES

- [1] The Edison Monthly, pp. 57–58, March 1925.
- [2] “Compact fluorescent lighting in America: Lessons learned on the way to market,” Pacific Northwest National Laboratory, June 2006.
(http://apps1.eere.energy.gov/buildings/publications/pdfs/ssl/cfl_lessons_learned_web.pdf)
- [3] Granitz, R. F., “Levels of packaging,” Inst Control Sys., August 1992.
- [4] Wikipedia contributors. "Timeline of lighting technology." *Wikipedia, The Free Encyclopedia*. Wikipedia, The Free Encyclopedia, 25 Mar. 2010. Web. 27 Apr. 2010.

FASTON, NECTOR, TE (Logo) and, Tyco Electronics are trademarks of the Tyco Electronics group of companies and its licensors. Other products, logos, and company names mentioned herein may be trademarks of their respective owners.